

# Palintest

Water Analysis Technologies

## Lumiso Expert User Manual



## Registration and technical support

Thank you for choosing a Palintest Lumiso Expert Photometer. If you haven't done so already, please register your instrument at [www.palintest.com/products/lumiso-expert](http://www.palintest.com/products/lumiso-expert) or scan the QR Code.

In addition, the latest version of this manual can be downloaded and there are supporting documents and printable test instructions as well as firmware updates and access to Palintest Connect.



## Intended Use

Lumiso is a measurement and data management platform for water testing. It is used for testing drinking water, wastewater, process water, environmental waters and swimming pool/spa water. It is employed in industries such as food and beverage, utility companies and the humanitarian sectors amongst many other industrial, scientific, education, health, and manufacturing applications.

The data is used in reports for audits, records, quality control, process control, and trend analysis.

### **Lumiso offers:**

- Reliable, high-quality results with less risk of user error.
- Traceable data record of 10000+ results.
- Data enrichment with application and test information.
- IP67 certified with waterproof USB type C port.

## Important Safety Information

Please take time to read and follow the advice in this manual.

If this instrument is used in ways not specified, the protection it provides, and its accuracy may be impaired.

Avoid replacing batteries in wet or humidity condensing locations.

Please read and follow all the safety information supplied with your Palintest reagents.

## Contents

Registration and Technical Support	2	<b>Home Screen Menus</b>	18
Intended Use	2	Test selection menu	18
Important Safety Information	2	Test Log	19
<b>Getting Started</b>	4	Users	21
Instrument Layout	4	Labels	21
The Home Screen	5	System Settings	22
<b>How to select and perform a test</b>	6	Sleep Delay	23
Basic principles of photometric tests	6	Brightness	23
Blanking	7	Date Format	23
Generic outline of the test procedure	7	Date and Time	23
Information Messages	10	Language	23
Achieving best results	11	Buzzer	23
Ensure accuracy by Blanking correctly	11	Labels	24
Best practice when testing	11	Users	25
Dilutions	12	Units	25
<b>Setting Pass and Fail limits for a test</b>	14	Temperature	25
Why set Pass and Fail Limits	14	<b>Care and Maintenance</b>	26
How to set pass and fail limits	14	Keeping the optics clean	26
Creating a label	15	Check Standards	26
Adding a Parameter to a Label	16	Verifying all wavelengths	28
Setting the limits	17	Updating Firmware	29
		Battery replacement	31
		Notes on Battery Changing	32
		<b>Technical Specification</b>	33
		<b>Technical Support/Contact</b>	34

## Instrument layout



## The Home Screen

From powering up, the home screen appears and provides access to all functions.

Display a list of either

- All Tests on the instrument
- or
- Favourite Tests

- Set up Lumiso for your set of check standards
- Use regularly to verify the calibration

- Access the log of past test results
- Set filters to view subsets of results

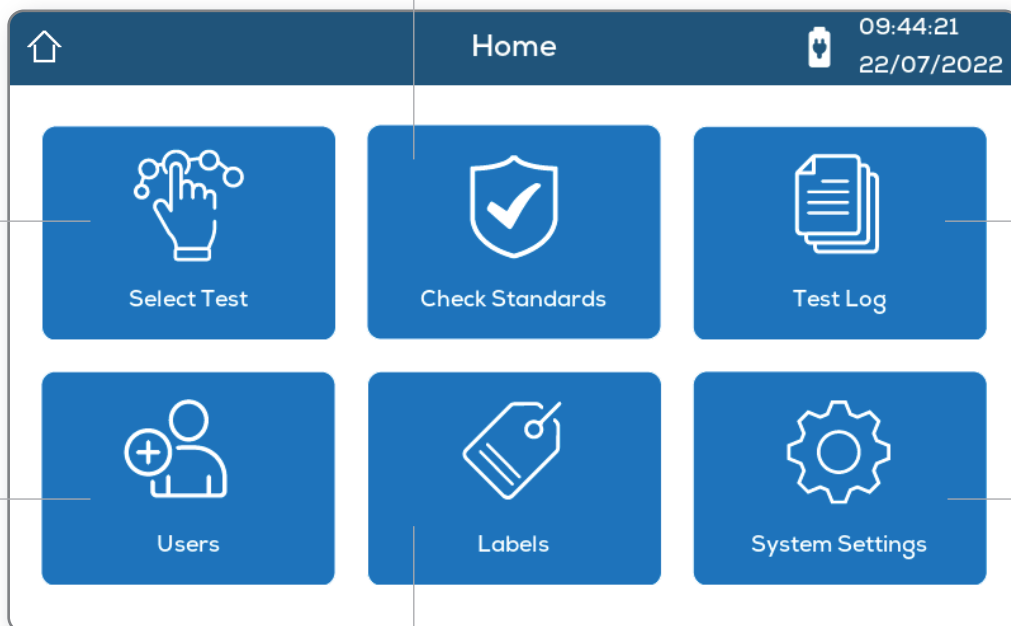

- Add up to 50 user names
- These can then be attached to test results

- Set up labels that can then be used to tag different test results to aid filtering

- Set up and customize various functions on your Lumiso Expert

# 6 How to Select and Perform a Test

## Basic principles of photometric tests

Photometric testing, also called colorimetry, involves adding reagents (e.g. tablets, powders, or liquids) to a water sample.

The reagents will be designed to react with a particular chemical of interest in the sample and form a coloured solution. So, by measuring the strength of that colour, the concentration of the chemical can be calculated.

Once the sample has been prepared by adding reagents, Lumiso sends light of a chosen wavelength through that sample and measures the level of light that passes through. This is then compared to the light level that passes through a "Blank" sample, that has no reagents.

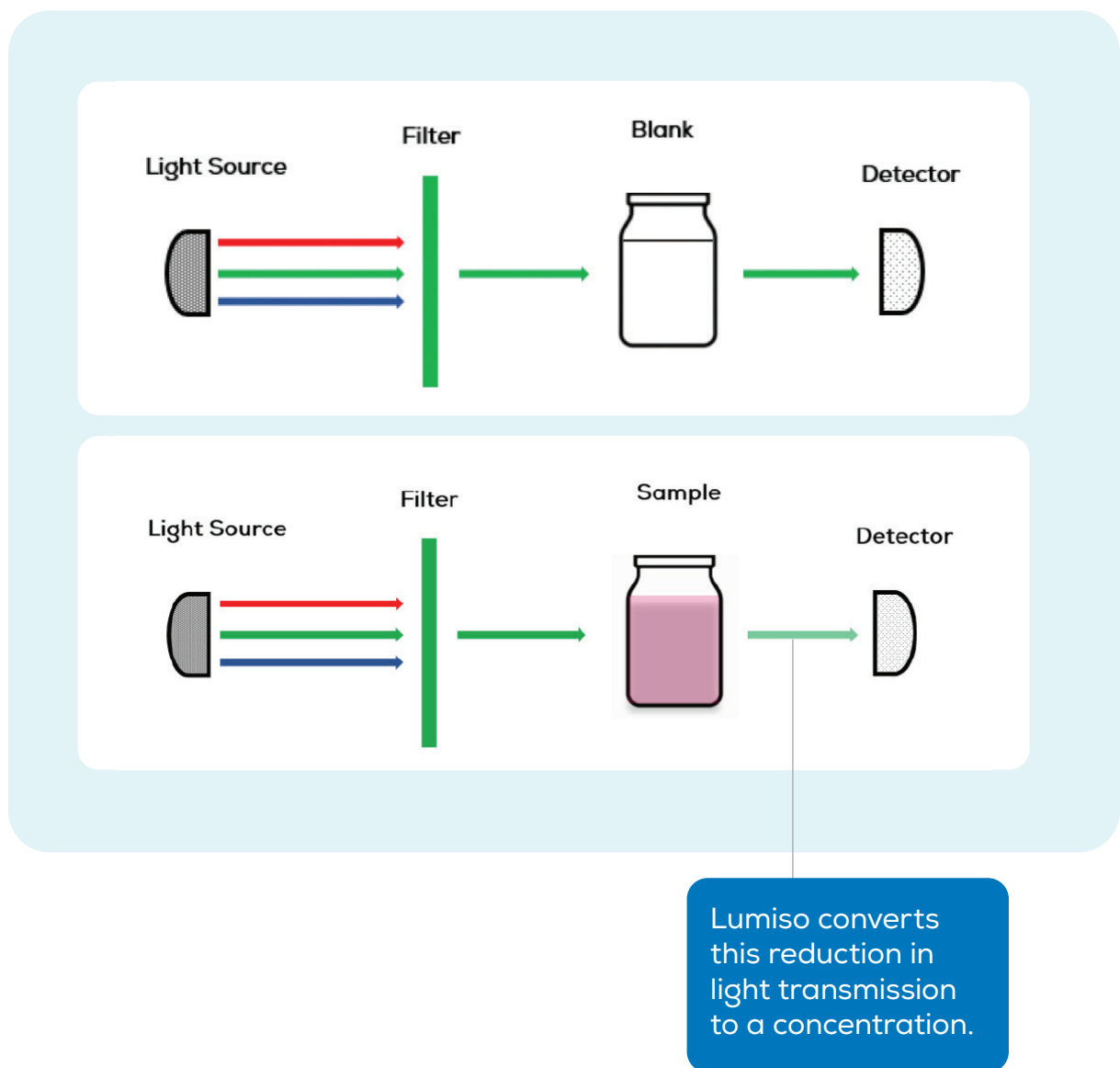

## Blanking

Blanking is the process that sets the zero value for the test. Since colour development is being measured optically, blanking ensures that any pre-existing colour or turbidity in the sample does not affect the final result. Usually, therefore, the “blank” tube contains a sample of the water being tested without any reagents added.

## Generic outline of the test procedure

Below is an outline of the basic procedure for the majority of tests. For specific test details please refer to the specific test instructions. These are available on the instrument here.

1

To “Blank” Lumiso place a clean photometer tube containing the water being tested, without reagents, in the cell holder.

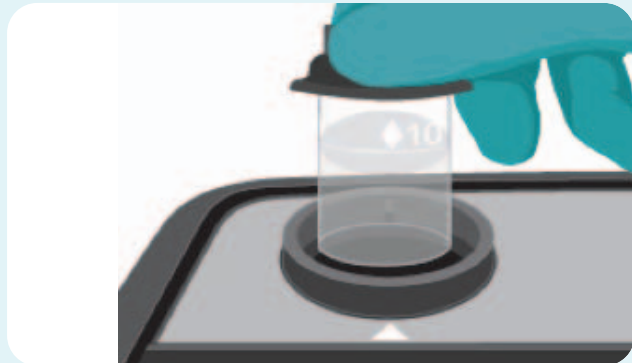

2

Press Blank



3

A progress bar will show that blanking is in progress.

Avoid moving the Blank tube during this time.

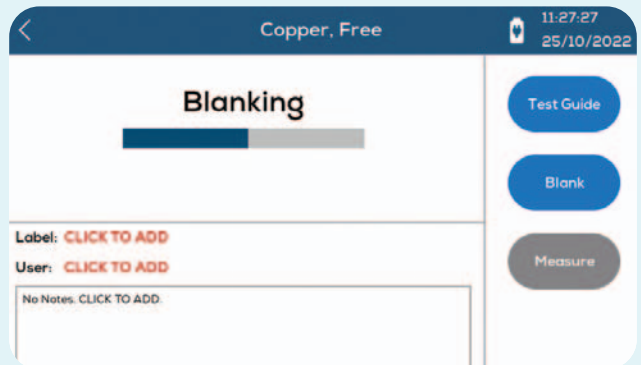

4

Instrument is successfully blanked and ready to measure the prepared sample.

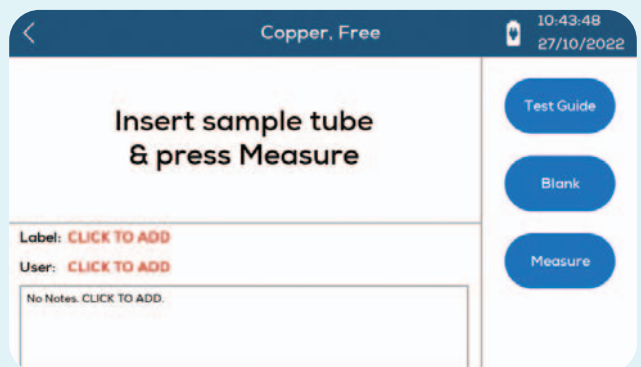

5

Prepare sample. Most often this involves adding reagents in tablet form. (Some tests may use liquid or powdered reagents).



6

A colour will typically develop.

Place the prepared sample tube in the cell holder.





7

Press Measure.

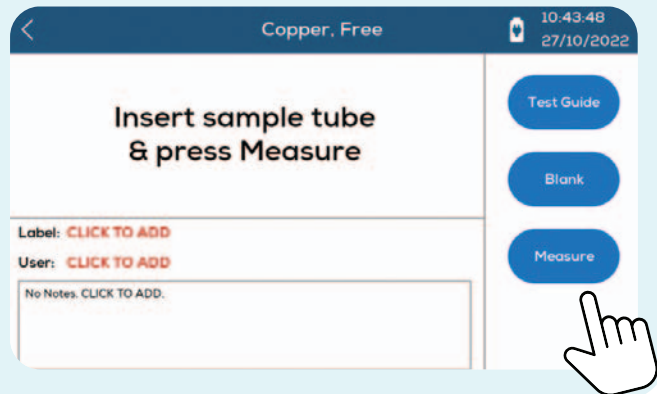

8

On some tests there will be a specified waiting time to allow colour development. This is preprogrammed in for each test and the timer will start automatically. Tests not requiring a wait time will commence measurement immediately.

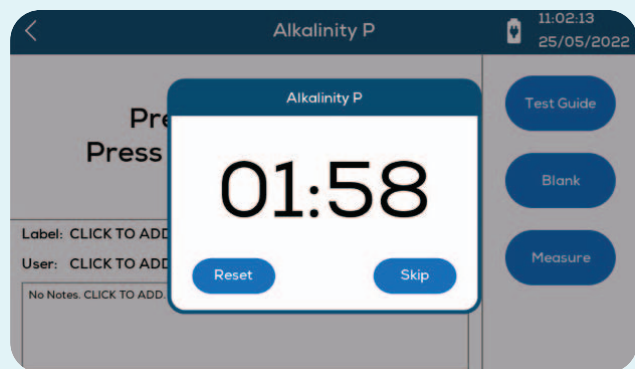

9

The result will then be displayed.

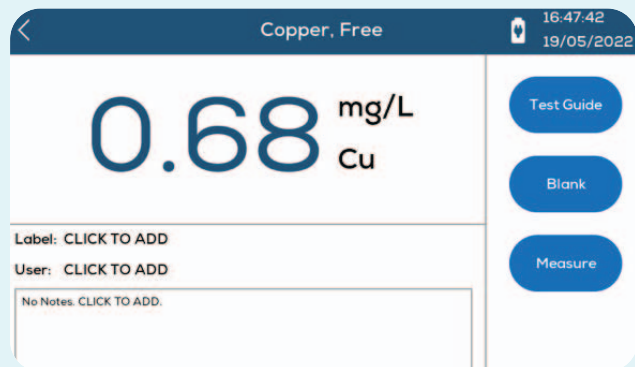

## Information messages

During the testing process, Lumiso performs checks to ensure that the test will be measured correctly. If it detects an event that would invalidate the result it will report one of the information messages below.

Message ID	Likely Cause	Suggested Action
<b>M1 and M2</b>	Blank is too dark.	Check and clean all glass tubes used. Repeat blanking process
	Contamination obscuring optics.	See: Keeping the Optics Clean
<b>M3 and M4</b>	Blank, sample tube, or NDF standard moved or removed too early.	Carefully repeat blanking and reading procedure.
<b>M5</b>	Tube cap is not excluding light from cell.	Check or change light cap on tube.
	External light entering the optical cell.	Move instrument away from external light.

A common cause that can trigger any of these messages to be displayed is contamination of the optical windows or stained glassware. See section below: How to achieve accurate results. If messages continue to be displayed, please contact your local Palintest branch or distributor.

## Achieving best results

### Ensure accuracy by blanking correctly

Blanking is a critical step as it sets the zero value for the test. In most cases the blank tube and sample tube should be identical except for the reagents (e.g. tablets) that have been added to the sample tube.

In some tests, pre-treatment of the sample such as dilution, filtering or conditioning of seawater is recommended. In this case, it will be this pretreated sample that needs to be used in the "blank" tube. Again, this will ensure that only the colour change in the specific reagents for the test parameter is measured.

### Best practice when testing

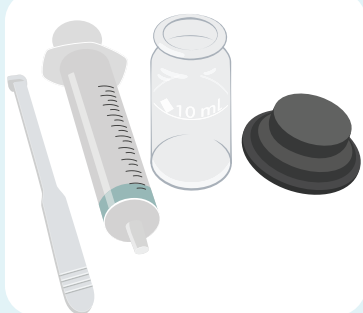

Rinse equipment thoroughly with deionised water or the water being tested.

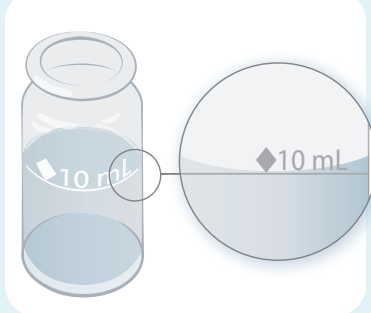

Measure volumes accurately as shown (or use a pipettor or syringe).



Use the correct Palintest reagents and observe all safety information supplied with them.

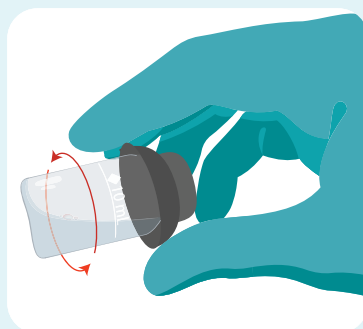

Check for bubbles and remove as shown.

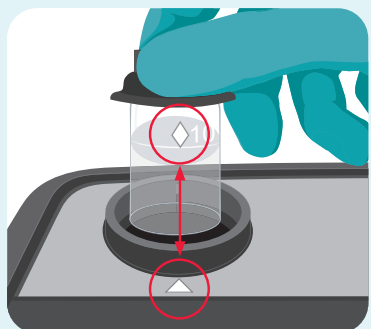

Align tubes as shown. Always use the tube cap as it excludes light from the optics.

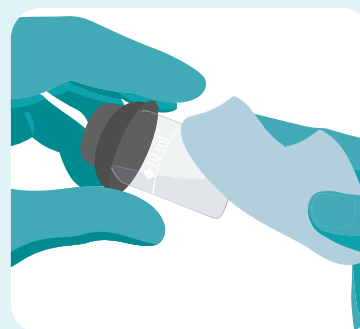

Keep instrument clean. Dry all tubes before placing in the optical cell.

## Dilutions

If the concentration in the sample is above the range of the test, the result screen will show the upper range level with a greater than sign ">" in front of it. It will then be necessary to dilute the sample and repeat the test.

Palintest's Dilution Tube is designed to make this process easy to carry out. It can be used to dilute the sample by a factor of 2, 3, 4, 5 or 10 times. If a higher dilution than this is required a 10mL syringe can be used with the dilution tube to dilute up to 100 times.

### Using the Dilution Tube

- 1 Assume you want to carry out a x2 dilution. (This means the sample volume will be doubled by adding an equal amount of deionised water).
- 2 Do this as follows.
- 3 Fill tube with sample to the x2 mark.
- 4 Then, top up with deionised water to the line marked 'Deionised Water' or "x1".
- 5 Cap the dilution tube and swirl to mix.
- 6 Use this diluted sample in the test in the normal manner. This includes blanking on the diluted sample.
- 7 Multiply the test result obtained by the dilution factor used (in this case x2).
- 8 Lumiso Expert can be setup to carry out the calculation automatically and store the calculated result in the log. This requires the use of Labels. See Setting Pass and Fail Limits for a Test.

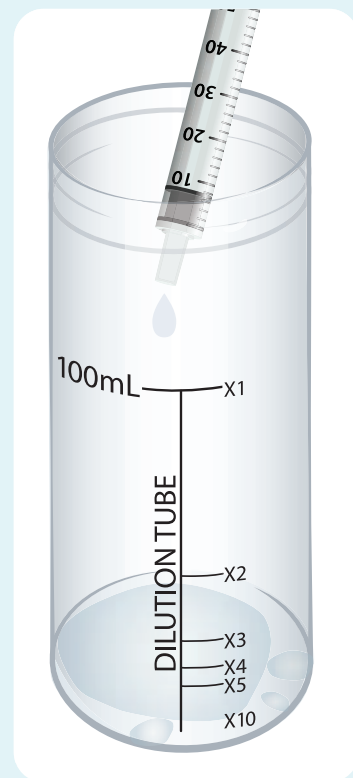

### Notes

- 1 Higher levels of dilution can be achieved by repeating the dilution process, then multiplying the two dilutions together.  
For example a x10 dilution, followed by a x2 dilution would result in a x20 dilution (10 x 2)
- 2 Dilution tubes and syringes should be rinsed thoroughly after use with deionised water.

## Use of a syringe and dilution tube for dilutions of x10 and higher

This is an alternative to the method given in note 1 above, for dilution levels above x10.

1. Decide on the degree of sample dilution required and consult the table below for the correct fill level in the syringe.

Required Dilution	Fill Syringe with Sample to this Level
x10	10mL
x20	5mL
x25	4mL
x50	2mL
x100	1mL

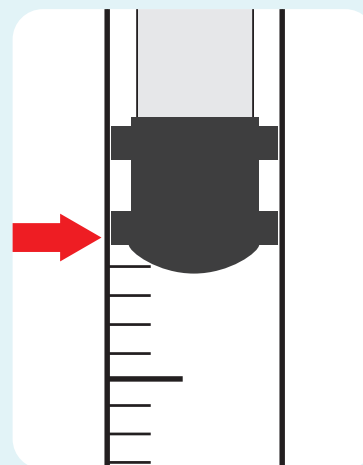

2. Place the tip of the syringe in the sample and draw some into the syringe. Adjust the syringe plunger until level corresponds to the appropriate fill level indicated in the table and illustration.
3. Expel the sample from the syringe into a clean dilution tube. Fill the tube with deionised water to the line marked 'Deionised Water' or 'x1'.
4. Replace the cap and invert several times to mix.
5. Use the diluted sample for the test in the normal manner.
6. Multiply the test result obtained by the dilution factor selected in the table.

For example, to prepare a x50 dilution, fill syringe to 2mL (as shown in table), expel this into dilution tube and top up with deionised water. The test result would then be multiplied by 50.

## Why set pass and fail limits?

Whatever the application is, Lumiso can be a powerful tool for managing the conditions in any water process or body of water. A system of labels allows relevant test parameters to be grouped together and pass and fail limits can be set separately for each label.

By setting limits for any test parameter, Lumiso can provide instant feedback to the operator carrying out the test as to whether the result is outside the expected or acceptable range.

This feedback on the test result appears in the results screen at the time and is recorded in the results log. Even if the limits are subsequently changed, the log result will continue to show that it was outside the acceptable range at the time of the test. Below is a typical results log.

Test ID	Value	Label	Timestamp
000268.mrsIt	>1000 FTU	Fish Pond	15:06:23 21/06/2022
000267.mrsIt	0.70 mg/L NH <sub>3</sub>	Fish Pond	15:49:56 02/06/2022
000266.mrsIt	0.57 mg/L N	Fish Pond	15:43:03 02/06/2022
000265.mrsIt	0.58 mg/L N	Fish Pond	15:03:44 02/06/2022
000264.mrsIt	0.05 mg/L N	Fish Pond	15:03:32 02/06/2022

"Passed" result

"Failed" result

## How to set pass and fail limits

The process for setting pass and fail limits involves the following three steps:

- Creating a label.
- Add a test parameter that you want to measure under that label.
- Set the limits for that parameter.

This is best explained with following example.

### Creating a label

So, let's assume we are testing a hot tub.  
We would start by creating a label called **Hot Tub**.

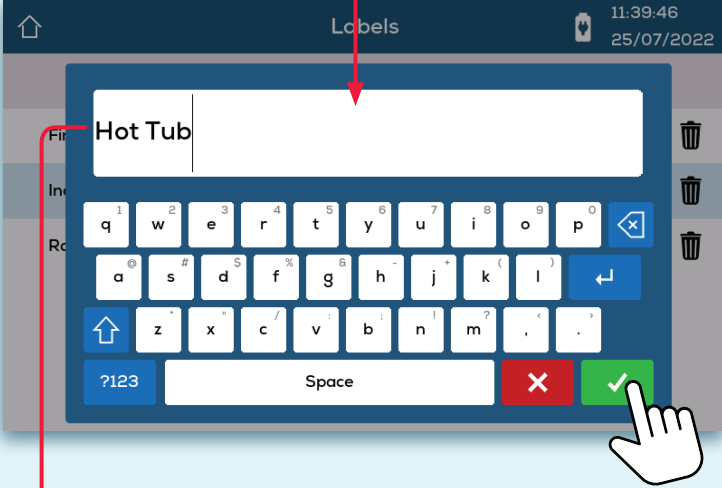
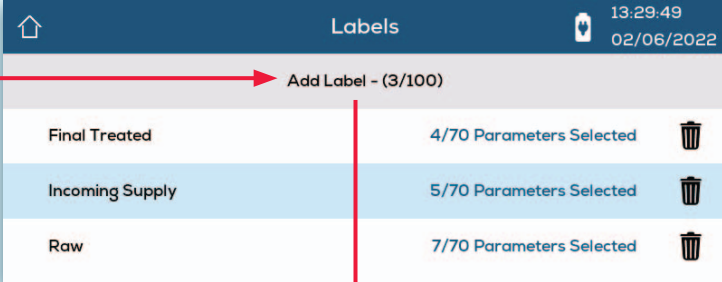

## Adding a parameter to a label

Note that next to the newly created label it says that there are no parameters selected. The label cannot be used until parameters have been added by pressing here.

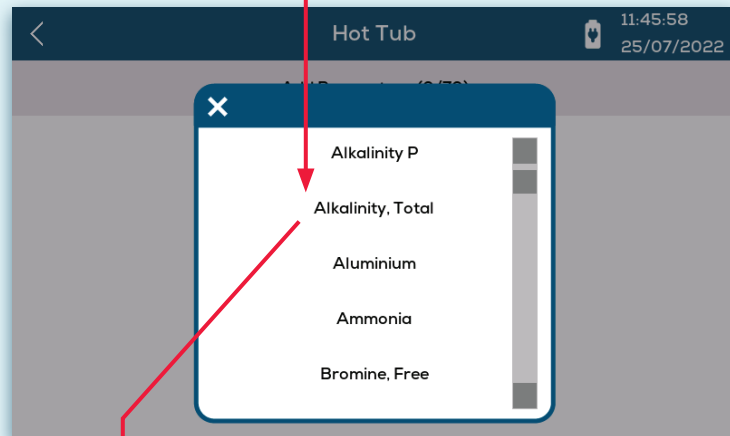
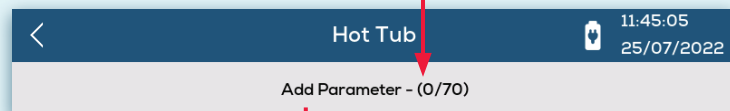
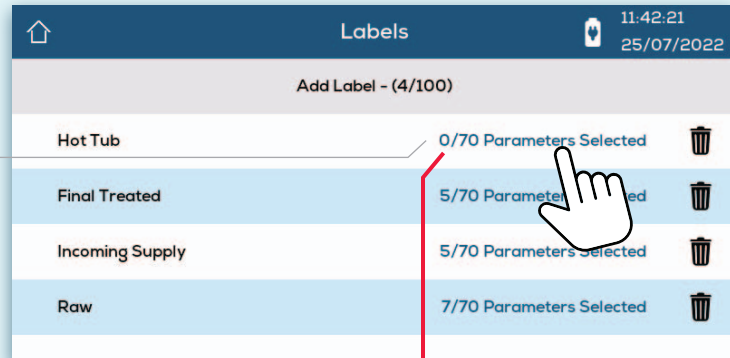

'Alkalinity, Total' has now been added as a parameter to this label. However, this indicates that no pass or fail limits have been set.

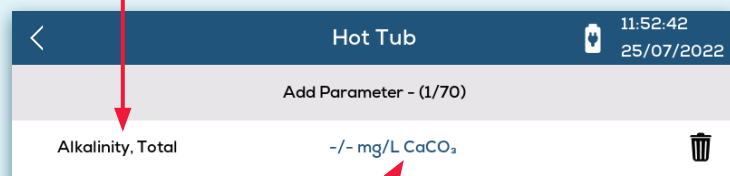



## Setting the limits

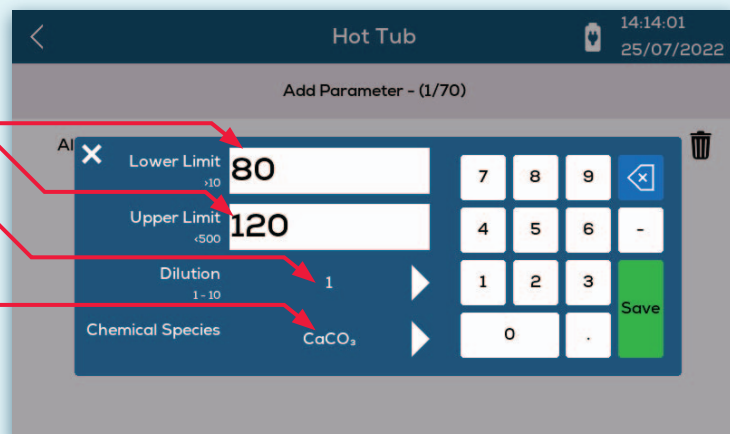
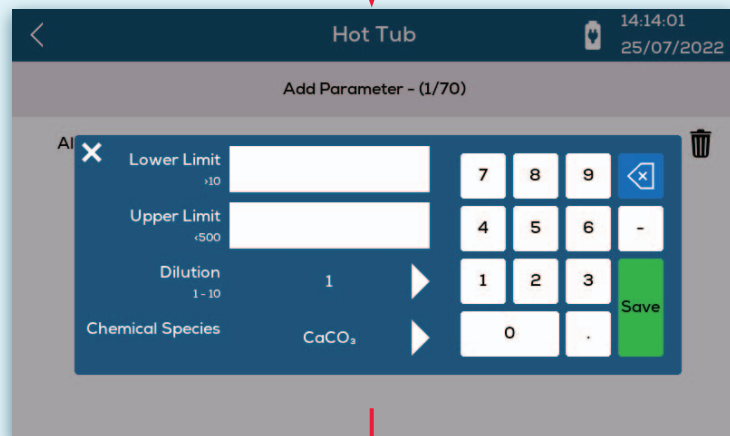
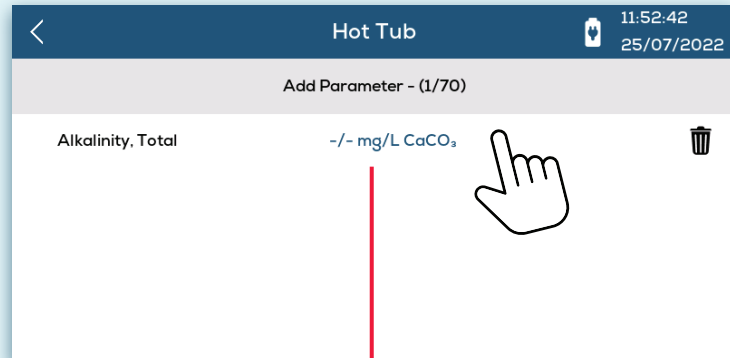

Upper and Lower limits have been set.

No dilution has been set. (1 = No dilution)

Chemical species is set to CaCO<sub>3</sub>



This accesses the test selection menu

Pressing this toggles between <All> and <Favourites> lists.

This shows the upper limit of the test.

This shows the chemical species currently selected for that test.

Test Name	Upper Limit	Chemical Species	Species Icon	Favourite Icon
< All >				
Acid Demand	10.00 mmol/L			☆
Alkalinity M	500 mg/L	CaCO <sub>3</sub>	🔗	☆
Alkalinity P	500 mg/L	CaCO <sub>3</sub>	🔗	☆
Alkalinity, Total	500 mg/L	CaCO <sub>3</sub>	🔗	☆
Aluminium	0.50 mg/L	Al		☆
Ammonia/IN Tablet	1.00 mg/L	N	🔗	★

Press the molecule icon to change the chemical species for the test.

The space here indicates that there are no alternative chemical species for this test.

Press the stars to add tests to your Favourites list.



CHECK STANDARDS

This has sub-menus for displaying the most recent instrument validation results and a simple process for storing values from the certificate to simplify the validation process. See section: Care and Maintenance/ Check Standards



TEST LOG

This enables viewing of all the test results in memory. The first screen shows the filtering options.

Selecting a filter, for example "Parameter", will result in a list of all parameters for which results exist.

Select one of these parameters, e.g. Bromine, Total and the results for that parameter are shown.

Sample ID	Result	Unit	Default	Time	Date
000273.mrslt	1.24	mg/L Br <sub>2</sub>	Default	10:12:17	24/06/2022
000272.mrslt	2.09	mg/L Br <sub>2</sub>	Default	10:12:10	24/06/2022
000222.mrslt	1.58	mg/L Br <sub>2</sub>	Default	12:12:54	27/05/2022
000221.mrslt	1.59	mg/L Br <sub>2</sub>	Default	12:00:59	27/05/2022
000220.mrslt	<0.04	mg/L Br <sub>2</sub>	Default	12:00:37	27/05/2022

If limits are set for a parameter the results are colour coded to indicate if the result is within the **pass** and **fail** limits set.

Sample ID	Result	Location	Time
000317.mrsIt	116 mg/L CaCO <sub>3</sub>	Hot Tub	14:52:17 25/07/2022
000316.mrsIt	53 mg/L CaCO <sub>3</sub>	Hot Tub	14:50:18 25/07/2022
000315.mrsIt	188 mg/L CaCO <sub>3</sub>	Hot Tub	14:49:55 25/07/2022
000314.mrsIt	336 mg/L CaCO <sub>3</sub>	Hot Tub	14:49:40 25/07/2022
000313.mrsIt	<10 mg/L CaCO <sub>3</sub>	Hot Tub	14:49:22 25/07/2022
000312.mrsIt	<10 mg/L CaCO <sub>3</sub>	Hot Tub	14:48:35 25/07/2022
000311.mrsIt	176 mg/L CaCO <sub>3</sub>	Hot Tub	14:48:23 25/07/2022

000317.mrsIt  
14:54:39  
25/07/2022

Alkalinity, Total  
25/07/2022 - 14:52:17

**116** mg/L  
CaCO<sub>3</sub>

Label: Hot Tub: 80/120 mg/L CaCO<sub>3</sub>  
User: Lab Tech 1

Filters Backwashed. 420 litres added

If any test line is selected it will reload the original test result screen and include any notes.

## QR Code

The QR code contains data on a section of the log with the most recent section appearing first. The results in this section can simply be scanned using the Palintest Connect Mobile App.

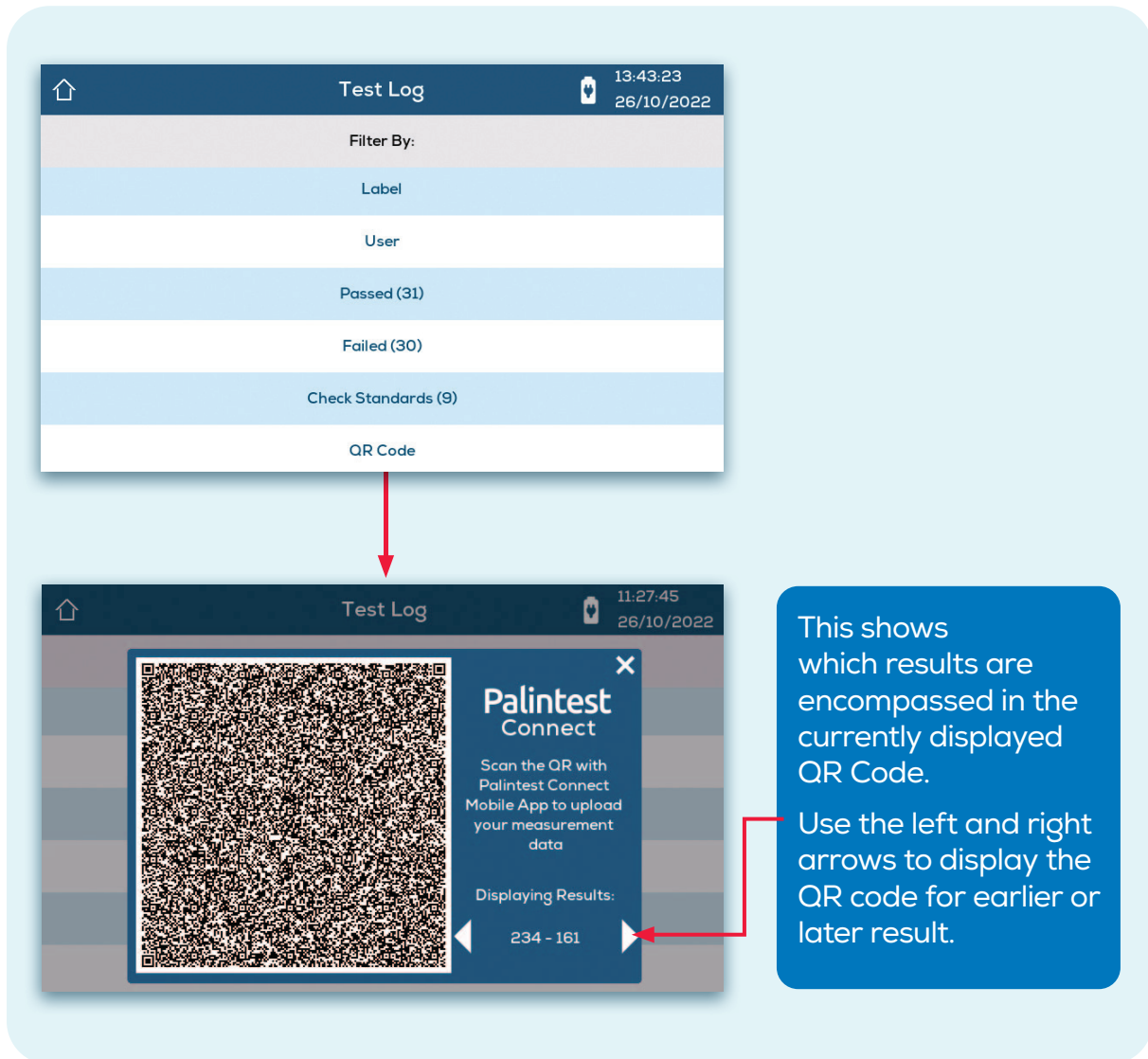

The top screenshot shows the 'Test Log' screen with a 'Filter By:' dropdown menu. The bottom screenshot shows the 'Test Log' screen with a QR code overlay and a 'Palintest Connect' dialog box. A red arrow points from the 'QR Code' option in the top screenshot to the QR code in the bottom screenshot. A blue callout box with a red arrow pointing to the QR code contains text explaining that the QR code displays results from 234 to 161 and can be navigated with left and right arrows.

This shows which results are encompassed in the currently displayed QR Code.

Use the left and right arrows to display the QR code for earlier or later result.

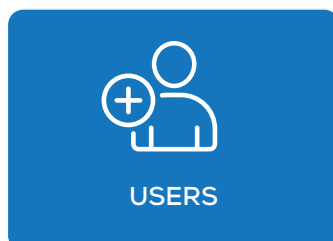

User names can be added to make it possible to record who carried tests.



Labels can be created, to allow sorting and grouping of test and parameter results and apply pass and fail levels. Labels are also used to set dilution factors which will automatically calculate and store the result correctly for tests that are attached to that label. See: Setting Pass and Fail Limits for a Test.



## SYSTEM SETTINGS

The menu below appears when System Settings is selected. Each of these will open a sub menu. Any changes to these settings will be saved when the instrument is turned off. Note that sudden loss of power (if instrument is powered solely by USB) may result in setting changes not being saved.

System Settings		15:33:08 25/07/2022
Sleep Delay	5 MINS	
Brightness	85%	
Date Format	DD/MM/YYYY	
Date and Time	25/07/2022 - 14:58	
Language	English	
Buzzer	Enabled	
Labels	Once	
Users	Once	
Units	mg/L	
Temperature	°C	
Device Info		

## Sleep Delay

Lumiso can be set so that it after a period of inactivity it will go on to a low power usage mode including shutting off the screen. The period can be set from 2 minutes to 20 minutes. Sleep can also be disabled completely. Lumiso will not go in to sleep mode when powered by USB.

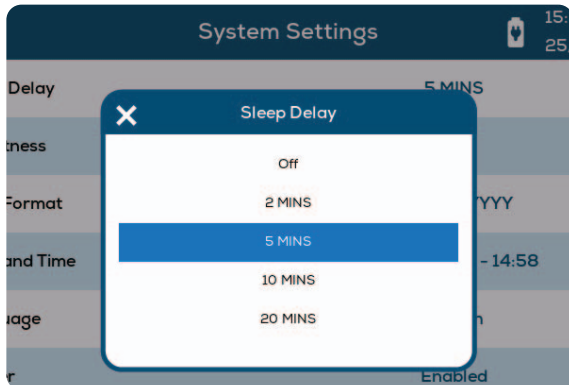

## Brightness

Screen brightness can be set from 0 – 100%.

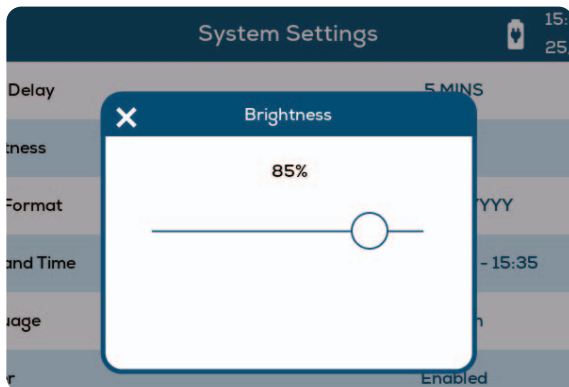

## Date Format

The Day(D), Month(M) or Year(Y) and be set to one of three format options.

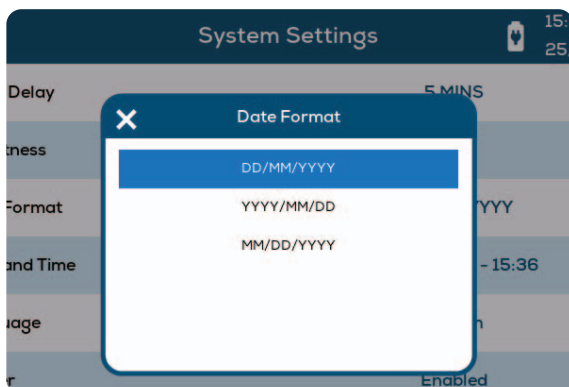

## Date and Time

Use up and down arrows to set correct date and year. Time is set using 24 hour format.

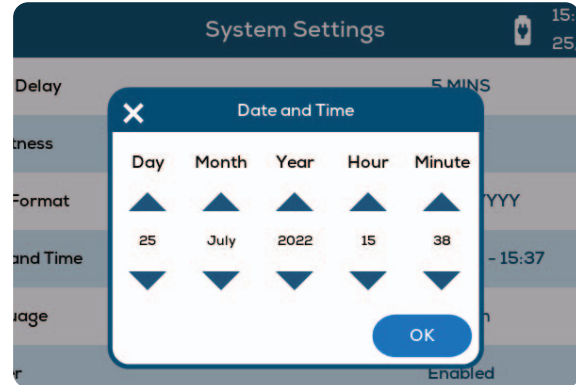

## Language

Selectable in English, French, Spanish and Chinese (Simplified).

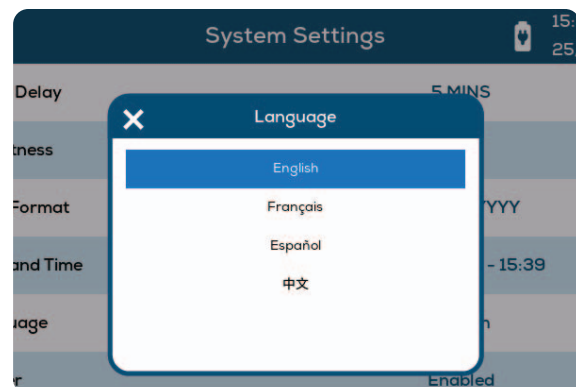

## Buzzer

The buzzer will sound when Lumiso is powered up and when the test timer expires, but can be disabled.

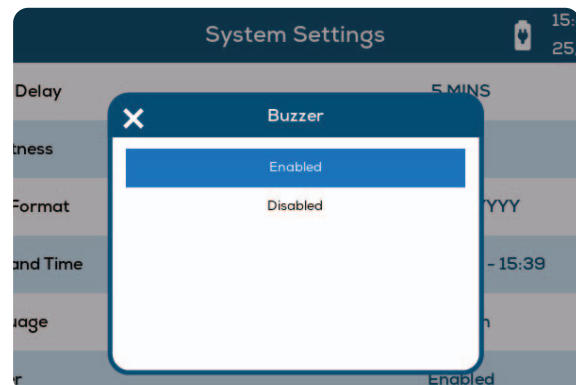

## Labels

If no label is selected the test result screen will show: **CLICK TO ADD**.

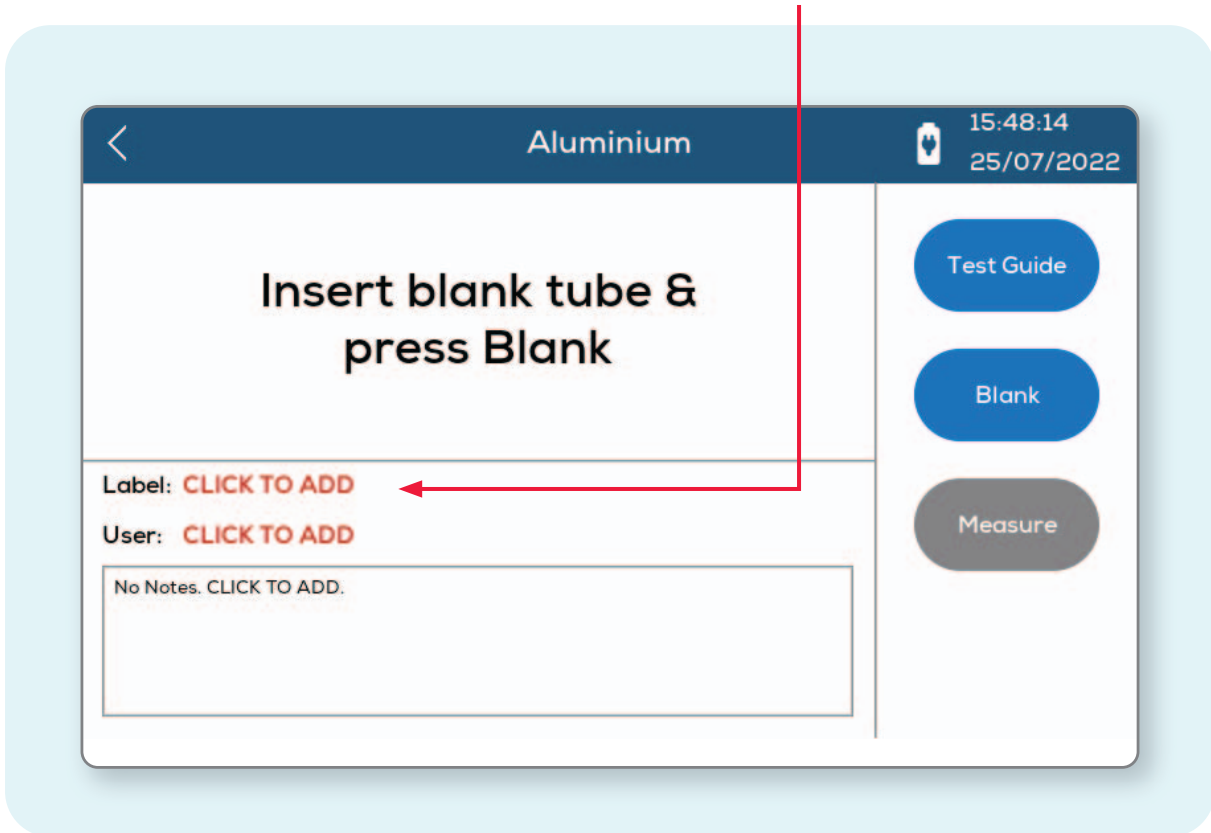

Lumiso can be set to prompt the user to attach a label to each result. (See: Setting Pass and Fail Limits for a Test).

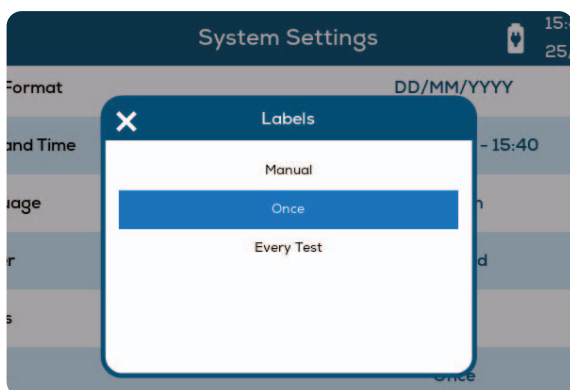

This option sets when and how often the user is prompted to add a label to a test result after a water test is carried out.

- **Manual** - There will be no prompting and results can be saved to the log without any label.
- **Once** - The tests results screen cannot be exited. This prevents the result being saved without a label being selected. Once a label has been selected, there will be no further prompts and that same label will be used for all future tests until the instrument is turned off.
- **Every Test** - There will be a prompt for a label every time a test is carried out. Any previously selected label will not appear on the test screen.



## Users

This functions identically to the above prompt settings for labels but is applied to Users.



## Temperature

Allows temperature when entered in the Langelier Index to be set to °C or °F.

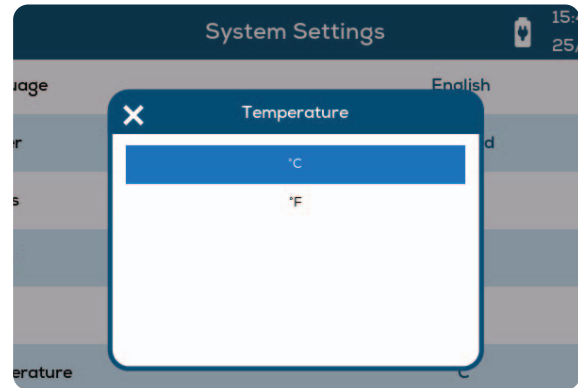

## Units

This enables the default concentration units to be switched from mg/L to ppm (parts per million). These are equivalent units and it is a personal choice which is used.

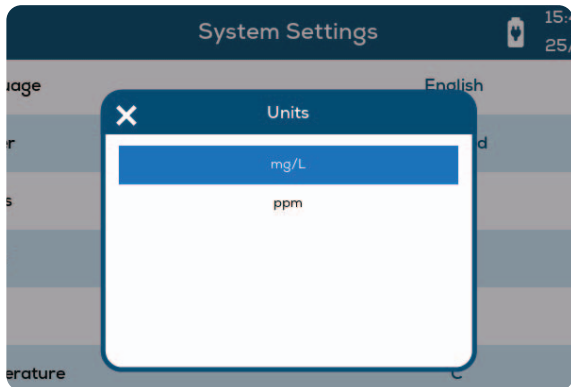

## Keeping the optics clean

The walls of the cell holder house an array of optical windows for the light sources and sensors. Therefore, any contamination in the optical cell may affect the accuracy of readings. If it is allowed to accumulate, it will trigger messages to be displayed (see: Information Messages).

Failures on some wavelengths when using check standards are also highly likely to be caused by surface contamination on the optics. This invariably affects some wavelengths more than others at first but over time will eventually affect all wavelengths.

Using photometer tubes that are wet on the outside can leave water droplets on the optics. These will act like lenses and can lead to erratic results, especially as they will be unstable and move due to vibration as the instrument is being used.

Clean optical windows gently with a soft, non-abrasive cloth dampened with water or anti-static foam cleaner. Do not use solvents.

**Please Note:**

**Instrument failures due to contamination will not be covered by the warranty.**

## Check Standards

Check Standards are available to purchase separately for the Lumiso Expert.



Using check standards is a simple way to verify the performance of the instrument and check that it is within calibration. Check Standards are comprised of neutral density filters in special holders. These absorb a similar level of light at all frequencies. Therefore, a single NDF can perform the same checks as the different liquid colour standards used with earlier Palintest photometers.

The value expected for each check standard is on a certificate that is supplied with the set. On the certificate is a 16 digit number that just needs to be entered once into Lumiso. As below:

This only needs to be done once by entering the 16 digit code from the certificate.



Assigned Values

Update Values



#B#j 6Pk+ z9C# #t\*4

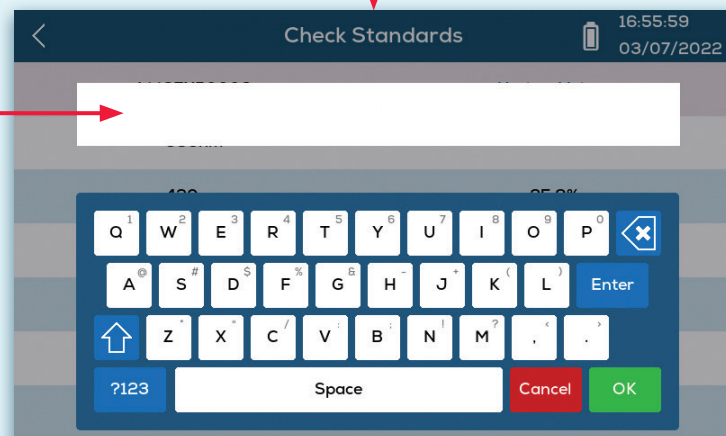

## Verifying all wavelengths

Select Measure All Wavelengths and follow onscreen prompts.

Use the Blank first in each position then insert NDF B and Measure every wavelength.



Measure All Wavelengths

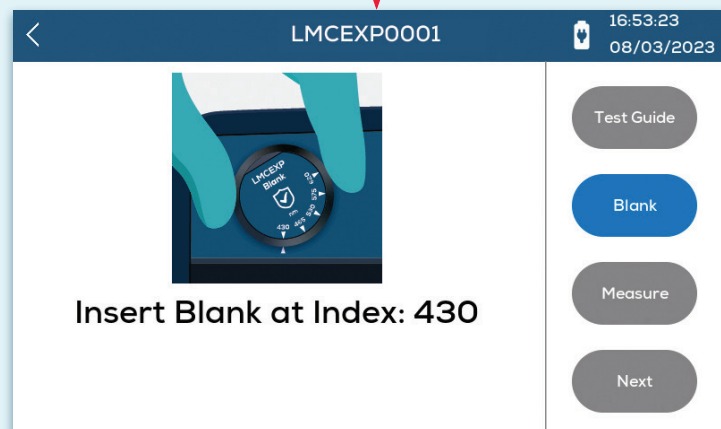

 A screenshot of a mobile application interface showing a table of measurement results. The title is "Check Standards" and the time is "11:21:05" on "20/04/2022". The table has four columns: "LMCEXP0001", "Result", "NDF B", and "Date and Time".
 

LMCEXP0001	Result	NDF B	Date and Time
430nm	PASS	71.7%	20/04/2022 - 11:18:49
465nm	PASS	71.6%	20/04/2022 - 11:18:53
530nm	PASS	72.5%	20/04/2022 - 11:18:58
575nm	PASS	72.6%	20/04/2022 - 11:19:50
620nm	PASS	72.1%	20/04/2022 - 11:19:18

**Note:** There is also an option for checking a single wavelength.

## Updating Firmware

Check for Firmware version in the System Settings → Device Info.

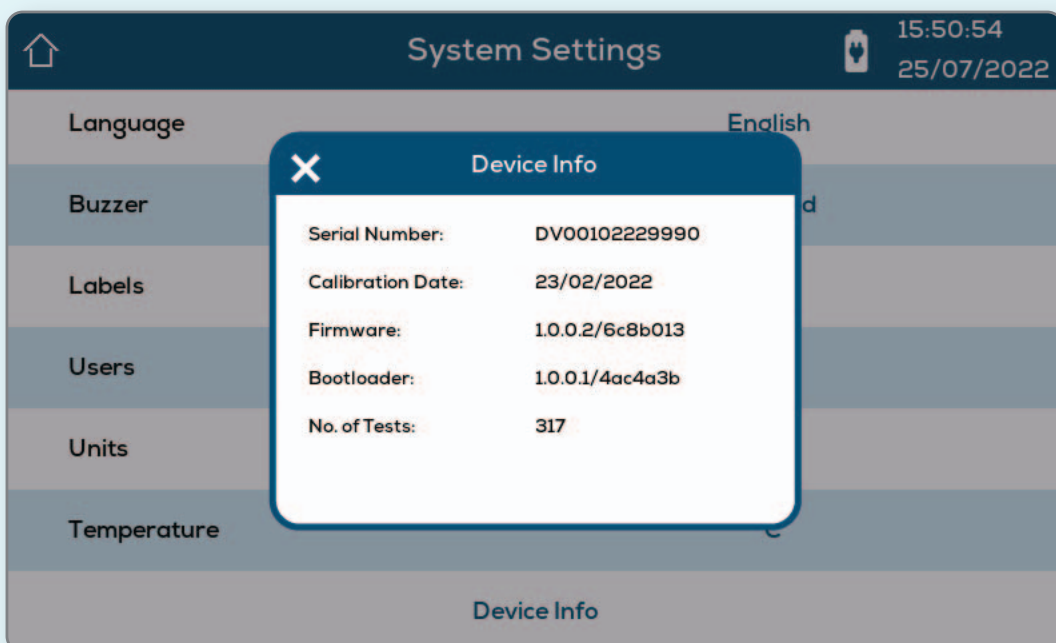
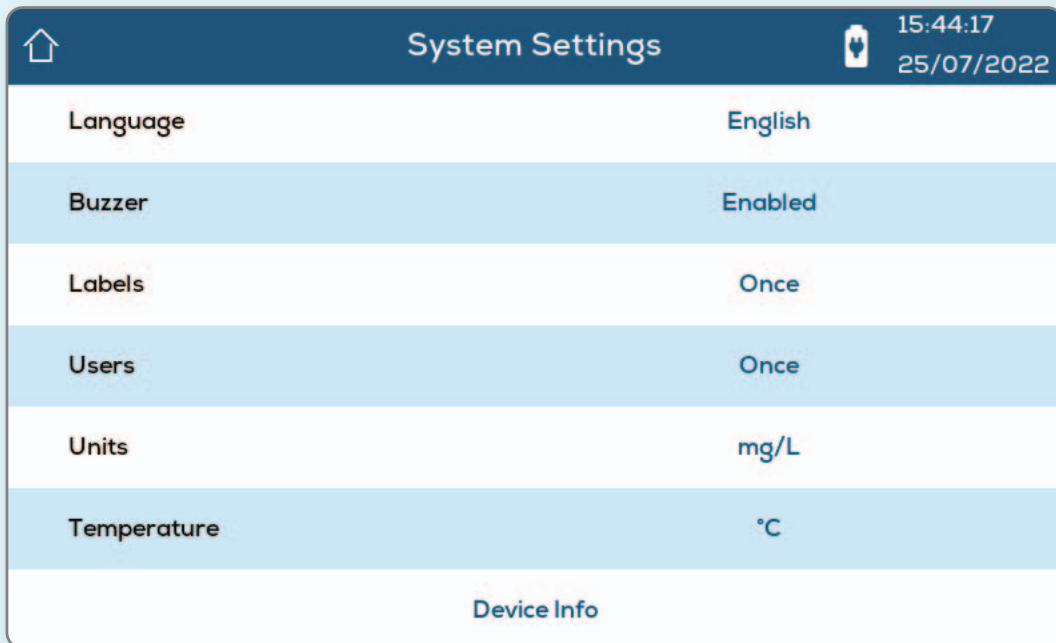

To update firmware, connect Lumiso to a PC using a USB A to C cable

Lumiso Instrument will appear as a Drive and can be renamed

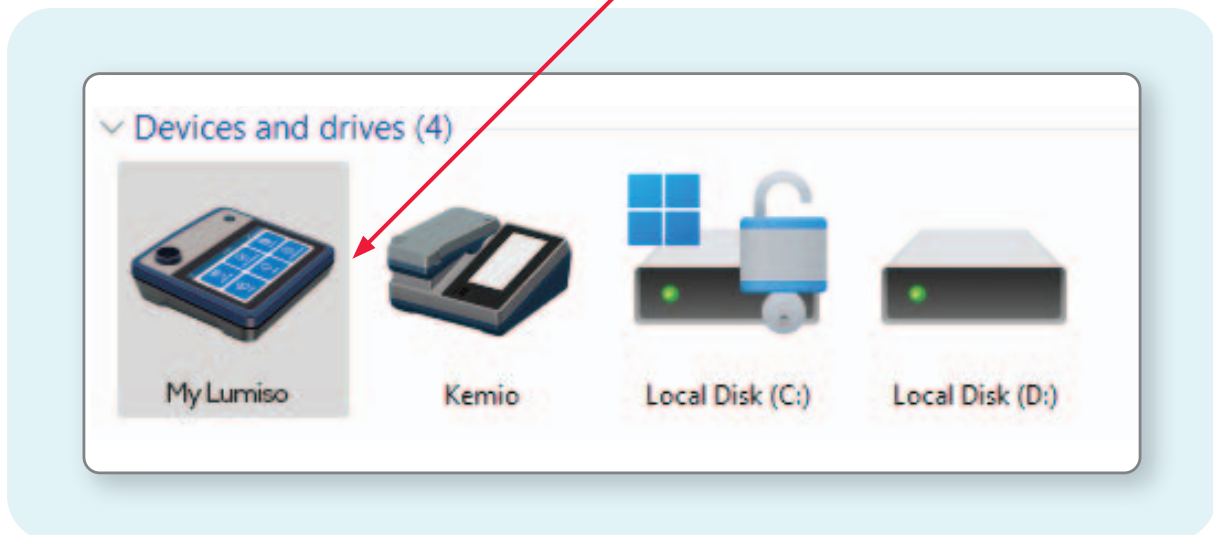

If a new Firmware file has been downloaded or sent electronically, drag and drop that file in to this drive.

Alternatively, Palintest Connect will automatically update firmware if the instrument is registered.

## Battery replacement

1

The battery cover is held in place with a clip. Push clip fully in and lift cover.

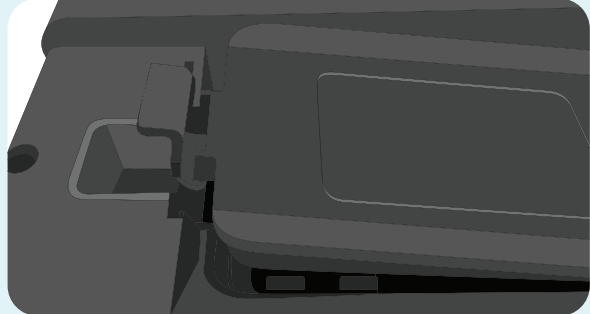

2

Use 6x 1.5V AA/LR6 batteries. Note polarity before replacing.

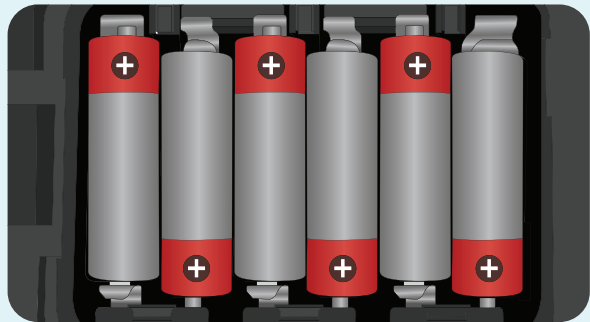

3

Spring clips hold the batteries securely in place. Push on the '+' end of the battery, and lift as shown.

Insert new batteries in the same way but pushing down.

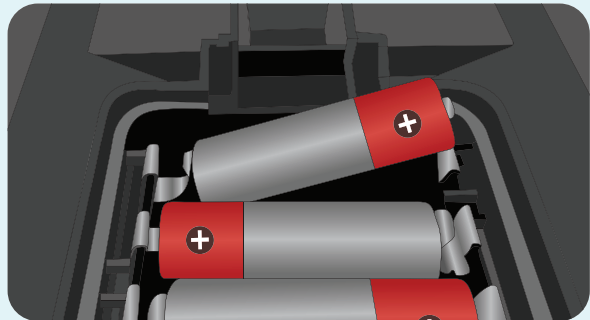

4

Push battery clip in gently and push cover down until the clip locks. This will maintain the IP67 water seal.

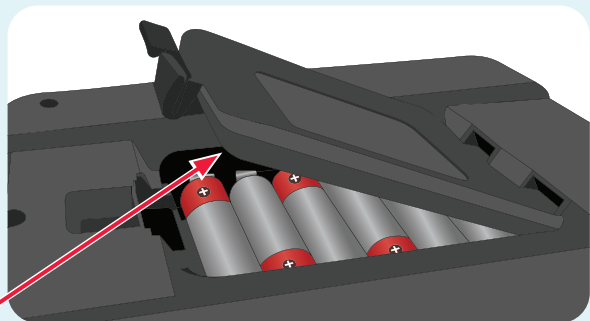

**Note:** The seal is pushed through the casework in battery compartment, so does not require strong downward pressure to be watertight.

## Notes on Battery Changing

- Avoid replacing batteries in wet or humidity condensing locations..
- Disconnect the instrument from any other equipment before replacing the batteries.
- Take care to avoid damaging the seal.
- The battery monitoring symbol may not display correctly when rechargeable batteries are used.
- Dispose of used cells responsibly by ensuring they go for recycling.



<b>Instrument</b>	Lumiso Benchtop; multi wavelength, direct reading colorimeter
<b>Optics</b>	Palintest Multi LED light source optical system with narrow band wavelength filters and photodetectors
<b>Test tubes</b>	25 mm diameter 16 mm diameter (using adaptor)
<b>Blank / Zero setting</b>	Held in memory, can be reset at any time. Automatic reset if tube size is changed or instrument powered down.
<b>Measurement range</b>	0.1 to 100%T (0 to 3 Absorbance Units)
<b>Accuracy</b>	+/-1%T
<b>Wavelengths</b>	430 nm, 465 nm, 530 nm, 575 nm and 620 nm
<b>Wavelength tolerance</b>	+/- 2nm
<b>Filter Bandwidth</b>	5 nm
<b>LCD Display</b>	7in, 800 x 480 pixel with backlight
<b>Instrument Operating Conditions</b>	0 – 45°C; 90% Relative humidity, non-condensing Indoor and outdoor use Altitude up to 2000m, Pollution degree 4
<b>Ingress protection</b>	IP67 (Waterproof)
<b>Power supply</b>	6 x 1.5V LR6 (AA) batteries
<b>USB Port</b>	USB, type C; 6V max, 500mA max, DC
<b>Dimensions</b>	220 x 200 x 55 mm
<b>Weight</b>	850 g

Lumiso is manufactured in the UK by Palintest, please see technical support contacts by region below:

**UK:**

Palintest Ltd  
Palintest House,  
Kingsway,  
Team Valley,  
Gateshead,  
Tyne and Wear,  
NE11 0NS,  
UK  
<http://www.palintest.com>  
[sales@palintest.com](mailto:sales@palintest.com)

**Authorised Representative in the EU:**

Halma Europe DS BV  
J. Keplerweg 14,  
2048AC Alphen aan den Rijn,  
Netherlands

**USA:**

Palintest USA  
600 Corporate Circle, Suite F  
Golden  
CO 80401  
USA  
[info@palintestusa.com](mailto:info@palintestusa.com)

**AUSTRALIA PACIFIC**

1/53 Lorraine Street  
Peakhurst Business Centre  
Peakhurst  
NSW 2210  
Australia  
[palintest@palintest.com.au](mailto:palintest@palintest.com.au)

**CHINA:**

Room 1711  
Fanli Mansion  
22 Chaowai Street  
Chaoyang District  
Beijing 100020  
PRC